



- Dimming Control
- High Efficiency (Up to 91%)
- Active Power Factor Correction
- Constant Output Current
- Up to 305VAC Operation
- Waterproof to IP67
- Lightning Protection
- Comprehensive Protection Circuitry
- UL8750 & EN61347 Safety Approvals
- RoHS Compliant

Electrical Specifications

Input

Input Voltage	90-305VAC
Input Frequency	47-63 Hz
Leakage Current	1mA @ 277VAC
Input Current	1.3A @ 100VAC 0.6A @ 220VAC
Inrush Current	65A @ 230VAC/25°C/Cold Start
Power Factor	See table

General

Efficiency	See tables
Isolation	3kVAC input to output 1.5kVAC input to ground 0.5kVAC output to ground
MTBF (MIL-HDBK-217F)	350kHrs @110VAC, 1050mA model, 80% load, 25°C
Dimensions	7.64"L x 2.66"W x 1.46"H
Net Weight	2.20lbs.

Output

Output Voltage	See table
Start Up Delay	1 second maximum at 110VAC/220VAC
Line Regulation	±1%
Load Regulation	±3%
Ripple & Noise	3% pk-pk, 20MHz bandwidth
Overvoltage Protection	Latch mode; restart power to return to normal operation
Over Temperature Protection	110°C maximum internal component temperature
Short Circuit Protection	No damage to unit; auto recovery when fault removed

Note: All specifications typical at 25°C unless noted.

Environmental

Operating Temp.	-35°C to +65°C
Operating Humidity	10% to 100% RH, non-condensing
Storage Temperature	-40°C to +85°C

Safety & EMC

Safety Approvals

USA

UL8750 Approved
UL1012, UL935 Compliant
CAN/CSA-C22.2 No. 0
CSA-C22.2 No. 107.1,
CSA-C22.2 No. 250.0

Canada

Europe

EMI	EN55015 (Radiated & Conducted)
Harmonic Currents	EN61000-3-2
Voltage Flicker	EN61000-3-3
ESD Immunity	EN61000-4-2; 8kV air; 4kV contact
Radiated Immunity	EN61000-4-3
EFT/Burst	EN61000-4-4
Surge Immunity	EN61000-4-5 (2kV line-line; 4kV line-gnd)
Conducted Immunity	EN61000-4-6
Magnetic Field	EN61000-4-8
Dips / Interruptions	EN61000-4-11

Your Partners in Power.....

Power Partners, Inc. | 43 Broad Street | Hudson, MA 01749
Tel: (978)567-9600 | Fax: (978)567-9601
Website: www.powerpartners-inc.com

Specifications subject to change.
PIL100U-C-DT: 06/08/2010



Models and Ratings Chart

Nominal Output Current	Output Current Range (Note 3)	Output Voltage Range	Max. Output Power	Typical Efficiency (Note 1)	Power Factor		Model Number With Dimming Control (Note 2)
					110VAC	220VAC	
350mA	332mA - 368mA	172VDC - 286VDC	100W	91.0%	0.99	0.96	PIL100U-C350-DT
450mA	427mA - 473mA	132VDC - 222VDC	100W	91.0%	0.99	0.96	PIL100U-C450-DT
700mA	665mA - 735mA	86VDC - 143VDC	100W	90.5%	0.99	0.96	PIL100U-C700-DT
1050mA	997mA - 1102mA	57VDC - 95VDC	100W	90.5%	0.99	0.96	PIL100U-C1050-DT
1400mA	1330mA - 1470mA	43VDC - 71VDC	100W	90.5%	0.99	0.96	PIL100U-C1400-DT
1750mA	1662mA - 1837mA	34VDC - 57VDC	100W	90.5%	0.99	0.96	PIL100U-C1750-DT
2100mA	1995mA - 2205mA	29VDC - 48VDC	100W	90.5%	0.99	0.96	PIL100U-C2100-DT
2450mA	2327mA - 2572mA	25VDC - 41VDC	100W	90.5%	0.99	0.96	PIL100U-C2450-DT
2800mA	2660mA - 2940mA	22VDC - 36VDC	100W	90.0%	0.99	0.96	PIL100U-C2800-DT
3150mA	2992mA - 3307mA	19VDC - 32VDC	100W	90.0%	0.99	0.96	PIL100U-C3150-DT
3570mA	3391mA - 3748mA	17VDC - 28VDC	100W	90.0%	0.99	0.96	PIL100U-C3570-DT
4200mA	3990mA - 4410mA	14VDC - 24VDC	100W	90.0%	0.99	0.96	PIL100U-C4200-DT

Note 1: Measured at 220VAC input and full load.

Note 2: Additional suffix may be included to denote variations or modifications to the base product.

Note 3: Current rating factory set to nominal, unless otherwise specified.

Derating Curve

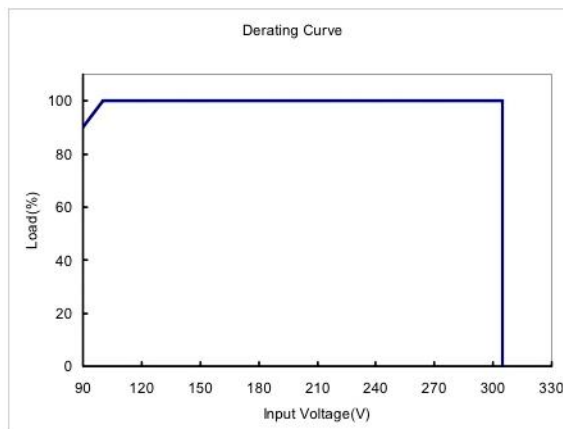
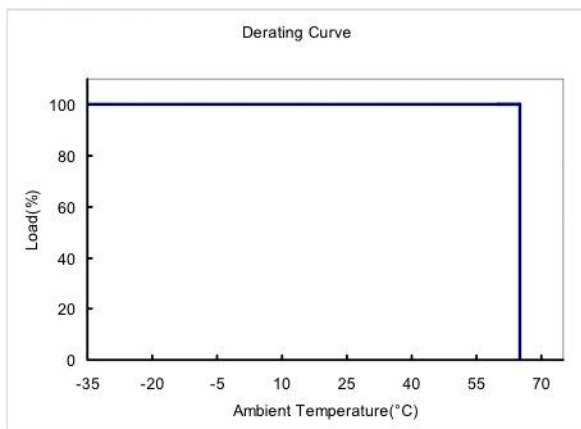

Your Partners in Power.....

Power Partners, Inc. | 43 Broad Street | Hudson, MA 01749
 Tel: (978)567-9600 | Fax: (978)567-9601
 Website: www.powerpartners-inc.com

Specifications subject to change.
 PIL100U-C-DT: 06/08/2010



Optional Dimming Control (Secondary Side)

Parameter	Min.	Typ.	Max.
10V Output Voltage	9.8VDC	10VDC	10.2VDC
10V Output Source Current	-10mA	---	10mA
Maximum Voltage on 0-10V Input Pin	0VDC	---	12VDC
Source Current on 0-10V Input Pin	0mA	---	1mA

Implementation 1: Potentiometer Control

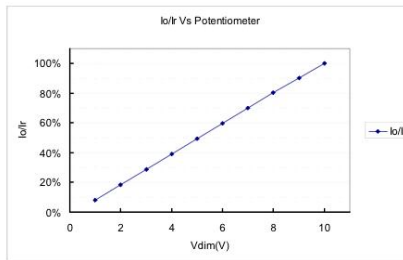

Note 1: If the dimming function is not used, short the 10V output pin (yellow) and the 1-10V input pin (purple)

Note 2: I_o is the actual output current and I_r is the rated current without the dimming control.

Note 3: For proper operation, the load voltage must be maintained above the minimum voltage threshold (approximately 60% of the maximum output voltage for any given model).

Note 4: If the output voltage is above 60% of the maximum, the dimming control will operate over the entire 1-10V range, while the output current is at 100% down to 10% load.

Note 5: The dimming signal may be less than 1V, however, from 0-1V, the output current linearity cannot be guaranteed.

Note 6: The recommended value of R_p , which is the potentiometer used in Implementation #1, is between 10K and 100K.

Note 7: To ensure proper operation, do not connect the GND of the dimming to the output

Implementation 2: DC Input

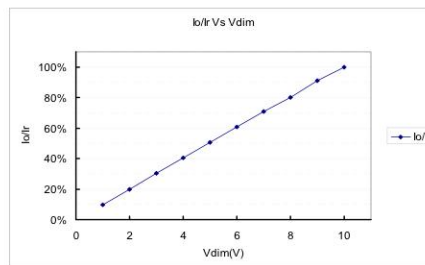
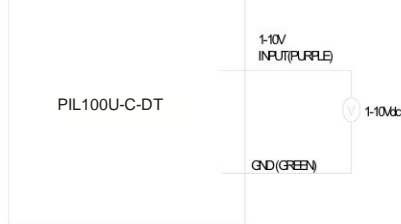

Implementation 3: External Resistor

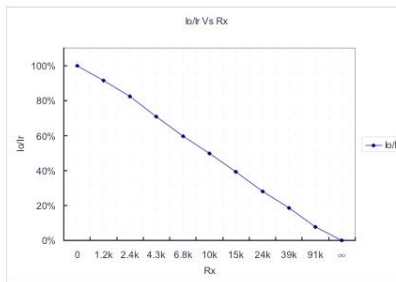
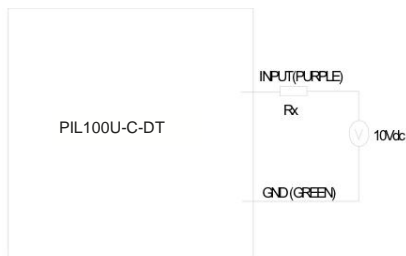

Implementation 4: External Resistor & DC Input

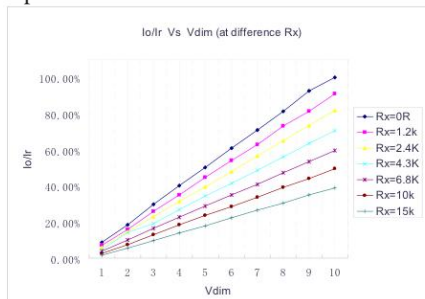
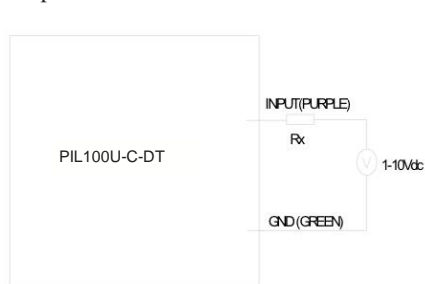



Mechanical Outline Drawing

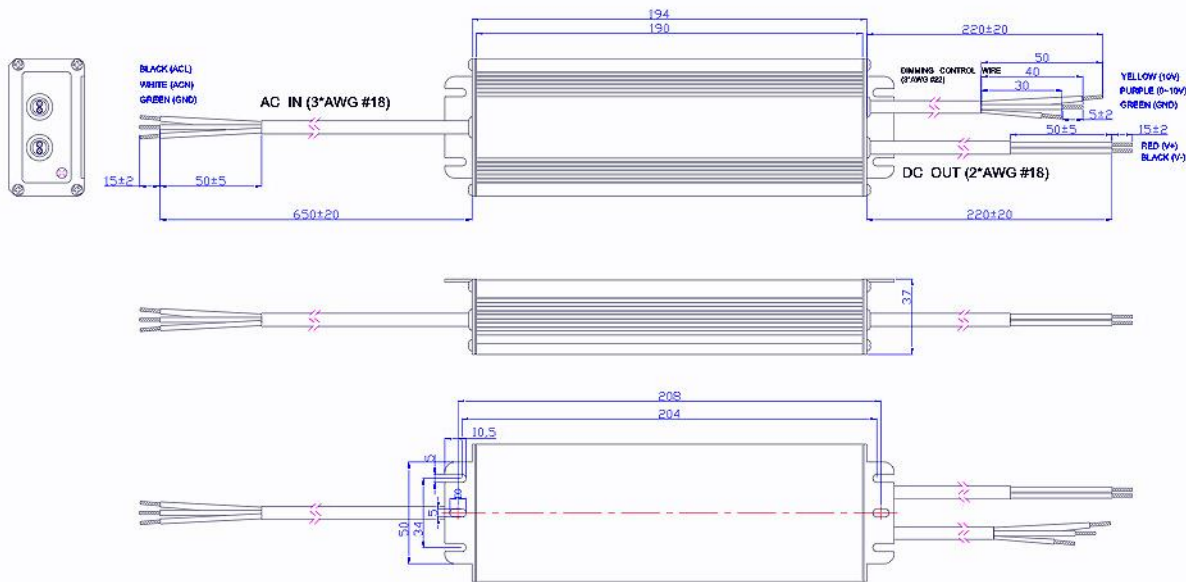

Your Partners in Power.....

Power Partners, Inc. | 43 Broad Street | Hudson, MA 01749
 Tel: (978)567-9600 | Fax: (978)567-9601
 Website: www.powerpartners-inc.com

Specifications subject to change.
 PIL100U-C-DT: 06/08/2010